

# workbench

APRIL – JUNE 2026

# WIN

1 OF 3 BRASS  
MONKEY PORTABLE  
FRIDGE/FREEZER

VALUED  
AT  
**\$300**  
EACH

PURCHASE  
**ANY CRC**  
PRODUCT  
FEATURED IN THE  
CATALOGUE TO AUTOMATICALLY  
GO INTO THE DRAW TO WIN!

CASH CUSTOMERS



SCAN TO ENTER!



























Starts 9:00 AM AEST 13/4/26. Ends 7:00 PM AEST 30/6/26. Open to AUST residents who fulfil the entry/eligibility requirements. Purchase any CRC product in the current Workbench catalogue. Cash customers must enter online. Account customers (upon making a qualifying purchase) will automatically be entered. Win 1 of 3 Brass Monkey 15L compact Fridges/Freezers. Total prize pool is \$900 (inc GST). Prize draw 3:00 PM AEST 14/7/26. Winners notified via email & phone by 16/7/26 and published at motion.com.au on 21/7/26. Promoter is Motion Australia Pty Ltd. ABN 32 000 143 608. 18 Worth St Chullora NSW 2190. For full T&Cs refer to motion.com.au.

SHOP ONLINE  
WITH US 24/7

**MOTION**  
Motion.com.au

# CONTENTS

 3	 4	 4	 4	 4
 5	 5	 5	 5	 5
 6	 7	 7	 7	 8
 8	 9	 10	 11	 12
 13	 14-15	 17	 18-19	 19



## 205L Oil Drum Pump Tube Assembly

Sealed system design eliminates the chance of foreign particle contamination.

- 3 piece threaded suction tube, can be adapted to suit both 205L and 60L drums
- Designed and engineered with performance, durability and serviceability front of mind

**\$254**



11205PTAALM

## Battery Operated 205L Oil Drum Pump

Supplied with a power head, lithium-ion battery, a battery charger & delivery hose.

- Drum adaptor & 3 piece threaded suction tube suits most 60L and 205L drums
- 21.6V 2.5Ah Li-ion rechargeable battery

**\$635**



11205ALM

## Automotive 3 x 205L Gantry Oil Drum & Delivery Kit

Steel frame self bunding oil gantry.

- 3 x 20m x 1/2" ID spring rewind oil hose reels
- 3 x Heavy duty 5:1 oil drum pumps

**\$8,589**



AA205-3DGALM

## 205L 4 Wheel Drum Dolly

205L/180kg standard duty wheel dolly.

Sturdy & WHS friendly, reducing the physical effect of handling drums.

- Industrial quality steel construction
- Includes 4 x 75mm heavy duty wheel castors

**\$149**



80100ALM

## Rewinda High Pressure Hot Water Washdown Hose Reel

High heat resistant wire braid hose.

- 20m x 10mm ID
- High heat resistant SAE 100R2 wire braid hose
- 3/8" BSPT(m) inlet hose & 3/8" BSP(m) outlet hose connections

**\$699**



AR1020HPWRALM

## Rewinda Chemical & Pesticide Hose Reel

Pesticide, weedicide & chemical resistant PVC hose for use in environments where chemicals are widely used.

- 20m x 10mm ID
- 3/8" BSPT(m) inlet hose & 1/4" BSP(m) outlet hose connections

**\$699**



AR1020WPRALM

## Rewinda Compressed Air Hose Reel

Air hose reel with high grade impact resistant UV stabilised covers. Supplied with a Gen3 hybrid polymer hose, a speed control brake system.

- 20m x 12mm ID with 0.9m lead in hose
- Highly flexible Gen3 hybrid polymer hose hose bend restrictors ensure a long service life for your hose assemblies
- 1/2" BSPT(m) inlet/outlet connections

**\$403**<sup>EA</sup>



AR1220CABALM Blue  
AR1220CARALM Red

## Rewinda Compressed Air Hose Reel

Industrial quality hose storage & retrieval system.

- 20m x 10mm ID Gen3 hybrid polymer hose with bend restrictors for durability
- 3/8" BSPT(m) inlet/outlet connections

**\$392**



AR1020CARALM



## Brushable Ceramic Red

High performance alumina filled brushable ceramic for sealing, protecting and repairing surfaces subject to erosion, corrosion and wear.

- Certified for potable water application
- Seals and protects industrial plant and equipment

**\$230**



D11760DEV

## Brushable Ceramic Blue

High performance alumina filled brushable ceramic for sealing, protecting and repairing surfaces subject to erosion, corrosion and wear.

- Provides long-lasting protection in harsh environments
- Protect pump casings, impeller blades, gate valves, water boxes and fan blades

**\$230**



D11765DEV

## Plastic Steel 5-Min Putty

A steel filled epoxy putty for general maintenance and repairs. Used for filling, rebuilding and bonding metal surfaces.

- Open time 5 Minutes, hardens in 1 Hour
- Resistant to chemicals and most acids, bases, solvents, and alkalis

**\$160**



D10240DEV



## ColdGal Cold Galvanizing Aerosol

An active zinc rich coating with 92% metallic zinc in dry film, providing maximum long term protection of steel from rust and corrosion.

- Long term corrosion protection, fast dry for quick repairs and maximum adhesion.
- Fast dry, touch dry in 20 minutes
- Toluene Free

**\$22**



GCGGAGAL

## RustPaint Black Gloss Aerosol

Single pack, epoxy modified enamel topcoat designed for industrial applications.

- Specifically formulated with anti-corrosive properties to protect and beautify both new and old metal surfaces.
- Designed for industrial applications requiring wear & tear protection

**\$23**



GRPBLGAL

## Ironize Rust Converter

A fast-reacting rust converter and sealer which can be applied directly to a rusty surface.

- Converts and seals rust in one easy step
- No residue to wash off before recoating, enamel paint can be applied after 3 hours.
- Phosphoric acid free

**\$220**



GICS4L GAL



## Foodlube Multi-Paste

A superior performance, white, food grade, non-toxic anti-seize and assembly paste developed for protecting fasteners and lubricating bushes, slides.

- Temperature range: -30°C to 450°C
- Highly resistant to water wash off

**\$58**



RY157524

## Food Safe Chain Lube 205L

A water resistant, non-toxic lubricant, for the lubrication of chains and associated bearings in clean industry environments.

- Will not wash off during cleaning operations
- Penetrates rapidly into pins and bushes

**\$3,986**

**BULK BUY DISCOUNT MOQ 4**



RY443935



## Supatuff Heavy Duty Neutral

A high build, epoxy-based surface coating, suitable for industrial environments to provide protection from damage or wear caused by chemical attack, abrasion, or erosion.

- Suitable for industrial floors with heavy vehicle traffic
- Potable water approved

**\$990**



E992827EPI



## Elevate e-ZED Active Bluetooth Earmuffs

With active listening and bluetooth dual connect for easy wireless pairing to your phone, enabling seamless calls and audio without compromising safety.



**NEW**  
\$75<sup>90</sup>

263-EEM110-ANZ

## VanguardG4 PAPR Complete Kit

- Lightweight, portable design
- LED display shows battery level, filter status, usage time, and airflow
- Smart filter monitoring tracks filter type and usage for optimal performance



\$1,320  
PRK-G4SR2P-1

## Mega Bullet Biosoft™ Earplugs Class 5 Uncorded

The world's first sustainable bio-based earplugs. Made from 82% bio-based materials.

- 76% decomposition after 180 days
- Slow rebound with a soft, smooth feel
- Tapered shape for easy installation
- Independently tested SLC80 33dB Class 5
- Box of 200



**NEW**  
\$46  
BSF-1-ANZ

## Arax Cut F Impact Gloves

ANSI Level 1 Impact rated to protect back of hand and fingers. Nitrile Sand Dip for extreme wet and oily grip.

- Seamless construction for enhanced comfort and breathability
- Sizes 7-12
- Velcro cuff closure for easy fitting



AIG-7 Size 7  
AIG-8 Size 8  
AIG-9PAR Size 9  
AIG-10 Size 10  
AIG-11 Size 11  
AIG-12 Size 12

\$1450<sup>EA</sup>



## Force Typhoon 8 Half Mask Respirator

Half Mask Respirator Asbestos/ Silica/Dust kit with P2 filters. Offers superior low breathing resistance and incorporates a 4-point suspension harness with quick release buckles.

- Handy Tub for clean storage
- Press to check filters



BHTOA3-OL5-UAN



\$45



## Hydration Shots - Zero

Thorzt (natural) 99% sugar free hydration shot 50 x 3g.

- Orange, Wild Berry, Mango, Pineapple, Strawberry, Watermelon and Grape
- All natural flavours, colours and sweeteners



\$37

SSSFZERO



## Petrol Pressure Washer

2700psi - 8.7LPM - 888 Series.

- 8m Braided Hose
- 3.7L fuel tank



T8240P

\$499

## Petrol Pressure Washer

2500psi - 9.7LPM - SP Jetwash - Solid Rubber Wheels.

- 8m Braided Hose
- 3.0L fuel tank



SP250P

\$849

## Field Service Tool Kit

7-drawer Off-Road Series tool box built for life on the back of work vehicles. Featuring heavy-duty wall construction, full roll cage protection, and an extreme-duty drop-down security panel to keep tools protected and secure. Available in 250-piece and 413-piece sets with Metric and SAE coverage for field service professionals.

From \$2,495



SP50118 250pc \$2,495  
SP50115 413pc \$3,595

## Inverter Generator

3300w 27kg Super Quiet Pull Start - 2 x 15amp outlets.

- Max Watts: 3300w (Starting Power)
- Rated Watts: 2500w (Running Power)



SPGI3300

\$999

## Inverter Generator

4800w 38.5kg Super Quiet Pull Start - Electric - 2 x 15amp outlets.

- Max Watts: 4800w (Starting Power)
- Rated Watts: 3800 (Running Power)



SPGI4800E

\$1,995

## Smart Battery Charger

Battery Type Supported: Lead Acid, AGM & Lithium.

- Overcharge protection, protecting the battery from damage due to overcharging
- LED indicators showing battery voltage, current and charging status

From \$99



SP61075 3.5A \$99  
SP61078 6.0A \$159  
SP61084 15A \$279  
SP61086 26A \$349



## CRC Aerostart 300G

A balanced formulation combining active, volatile solvents, upper cylinder lubricant and corrosion inhibitors, each designed to play a vital part in starting engines.

- Ensures, economical starting of all petrol and diesel engines

**\$18**



5051CRC

## CRC 5-56 400G

A superior penetrating power that breaks through rust and corrosion while it clears away scale and dirt.

- Multi-purpose lubrication
- Stops and attacks rust

**\$11**



5005CRC

## CRC Tac2 Chain Lubricant 300G

A tough adhesive lubricant that bonds to chain/wear surfaces to keep them in peak operating condition by reducing friction and wear that lead to metal fatigue.

- Reduces wear and friction
- Lubricates effectively chain drives, open gears, pulleys, wire ropes, conveyors

**\$18**



5035CRC

## CRC NF Tac-2 400G

Forms a strong bond with surfaces, minimising run off and offering long-term lubrication and corrosion prevention.

- Non-conductive and Non-corrosive ensuring safety during use
- Ideal for situations and environments where flammable vapours may become ignited and cause fire
- Non-Flammable

**\$15**



1754520CRC

## CRC NF 5-56 400G

A multi-purpose service spray that penetrates, lubricates and prevents corrosion.

- Ideal for mining and areas with low ventilation
- Non-conductive and Non-corrosive ensuring safety during use
- Non-Flammable

**\$16**



1754519CRC

## CRC Brakleen NF 500G

A powerful, heavy duty cleaner and degreaser for brake, clutch parts and general mechanical equipment.

- Quick cleaning and quick evaporating
- Non-staining, non-corrosive, no residue
- Non-Flammable

**\$12.50**



5087CRC

## CRC Glass Cleaner 500G

Uses a residue free formula and is versatile and safe enough to use on your most delicate glass surfaces.

- Professional strength
- Ready to use

**\$11.20**



3070CRC

## SmartWasher SW-33 Mobile Parts Washer - Starter Kit

SW-33 Mobile Parts Washer fits every application with its unique user-friendly design, large sink size, mobility and excellent features.

- Easy and efficient maintenance
- User-friendly design
- Compatible with SW-X1 OzzyJuice

**\$4,482**



SW-33-4CRC



### 3.4kVA Honda® Powered GX200 Petrol Generator

A hard working, light weight generator ideal for small appliances and hand tools.

- 3.1L Capacity
- 2 x 15A outlets



EP3400HSRGTE

**\$1,299**

### 8kVA Honda® Powered GX390 Petrol Generator

A popular choice for farmers and builders for when an economical and hard working power source is needed to get the job done.

- 6.1L Capacity
- 2 x 15A outlets



EP8000HSRGTE Recoil **\$2,745**  
EP8000HSREGTE Recoil & E-Start **\$3,399**

From **\$2,745**

### 8kVA Honda® Powered GX390 Petrol Generator with RCD Outlets

8 kVA Honda Powered Generator complete with all the extras suitable for work site usage. Featuring Work Safe approved RCD-protected outlets for prevention of electric shocks or equipment damage.

- 6.1L Capacity
- 2 x RCD Protected 15A outlets, 1 x 32A Circuit Breaker



EP8000HSRRCD-V2 Recoil **\$3,099**  
EP8000HSRERCD-V2 Recoil & E-Start **\$3,739**

From **\$3,099**



### Portable Power Station 1,200W 1,152Wh

A lightweight, easy-to-carry power station with advanced LiFePO4 battery technology for extra safety. From worksites and farms to weekend getaways, it's built to deliver silent and dependable power for tools, appliances or essential devices.

- AC, DC, USB-A, USB-C and wireless outputs
- AC and solar charging inputs



WC-BG1200

**\$1,199**

### 3.75 kVA (3,200W) Open Frame AVR Petrol Generator with E-Start

An AVR (automatic voltage regulated) generator with E-start. Supplied with transport kit (handles and wheels), this generator is Euro 5 emissions compliant.

- 15L Capacity
- 2 x IP66 15A; USB-C, USB-A outlets



AVR-WC-P3750

**\$1,099**

### 8.75 kVA (7,000W) Open Frame AVR Petrol Generator with E-Start

An AVR (automatic voltage regulated) generator with E-start.

The optional RCD (Residual Current Device) version provides an added layer of electrical safety to protect both users and equipment.

- 25L Capacity
- 2 x IP66 15A; USB-C, USB-A outlets
- Includes a transport kit



AVR-WC-P8750 - **\$1,769**  
AVR-WC-P8750RCD with RCD **\$1,959**

From **\$1,769**



### Copper Hammers

An excellent Dual-Purpose soft faced hammer for many engineering & industrial applications. The Copper face combined with the malleable iron head gives a SAFE but high-impact blow.

- Ideal where a heavy blow is required combined with a relatively small striking area
- Replacement faces available



From **\$82**

TH310THO 32mm 830g **\$82**  
TH312THO 38mm 1,260g **\$115**  
TH314THO 44mm 1,940g **\$149**  
TH316THO 50mm 2,830g **\$229**

### Copper/Rawhide Hammers

The Copper face combined with the malleable iron head gives a SAFE but high-impact blow, whilst the hide face gives a firm resilient blow that will not mark the finished work.

- Ideal where a heavy blow is required combined with a relatively small striking area
- Replacement faces available

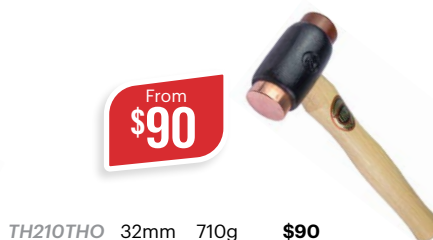

From **\$90**

TH210THO 32mm 710g **\$90**  
TH212THO 38mm 1,070g **\$125**  
TH214THO 44mm 1,600g **\$157**  
TH216THO 50mm 2,380g **\$219**

### Deadblow Nylon Hammers

Due to the easily interchangeable faces, these hammers are ideal as a multi purpose striking tool, for sustained and effective blows without recoil. Used in most assembly/fitting applications including engineering, toolmaking, shopfitting, partitioning, double glazing etc.

- Prevents rebound and delivers 'dead' blows of maximum force without damaging the workpiece
- Replacement faces available



From **\$90**

TH1212NTHO 38mm 700g **\$90**  
TH1414NTHO 44mm 900g **\$105**  
TH1616N 50mm 1,150g **\$121**  
TH2020NTHO 63mm 1,850g **\$175**

## HYDAC

### HMG 4000

Portable hand-held measuring and data logging unit for hydraulic systems.

- 5.7" full-graphics colour touchscreen display
- Records up to 38 sensors simultaneous
- 8 analogue, 2 digital and 28 HSCI sensors via CAN bus
- Measures pressure, temperature, flow rate and position



**\$12,728**

HMG 4000-000-E

### FCU 1000 Series

A portable instrument measuring particle contamination, water saturation, and temperature in hydraulic systems and diesel fuels, with an integrated pump, hoses, and time-stamped data for analysis via HYDAC's FluMoS software.

- Cleanliness classes per ISO, SAE, or NAS
- Suitable for hydraulic fluids up to 350 mm<sup>2</sup>/s (up to ISO VG 68)



**\$23,228**

FCU1310-4-U-AS-1

### Offline Drum Filtration Unit – ODF

The Offline Drum Filtration is an oil conditioning unit for filtering & dispensing 200L drums of oil. The high quality HYDAC filter elements and desiccant breathers ensure the oil is kept in optimal condition and ready for use.

- Easy & safe operation
- Suitable for a wide viscosity range



**\$24,267**

ODF-S-G-N-1-N-1-B-4363

### Mobile Filter Unit - MFU

The Mobile Filtration Unit works as a portable service unit for filling hydraulic systems, for flushing small hydraulic systems and for cleaning in bypass flow.

- An improvement in service life for components and system filters
- An increased oil service life



**\$6,032**

MFU-15S9-SF-FE-/T006

### Offline Filtration Trolley – OFT3

An offline filtration trolley with a flow capacity of up to 15 l/min and pressure capacity up to 5 bar. It is a mobile oil service unit used for filtering oil during system filling, transferring hydraulic or lubricating fluids, and providing offline fluid filtration.

- A variable speed drives to handle a large viscosity range
- A transfer of oil while bypassing filters



**\$26,838**

OFT-3-N-1-F-1B

### H2GO® - Water Removal Purifier / Vacuum Dehydrator

Separates free and dissolved water and dissolved gases from hydraulic and lubrication fluids. Includes AquaSensor AS1000 for continuous water monitoring and a 3-stage heating system to improve dewatering of higher viscosity and cold fluids.

- Extremely low residual water and gas levels in the operating fluids
- Reduced life cycle costs



**\$114,345**

H2GO-27-M-2-B-10-R-H-00/AU-983

## TOOLS4INDUSTRY

### Master Auto Panel Restoration Kit

10pc kit includes: Door skin hammer, flat dresser hammer, fender & panel dinging hammer, angle dolly, high crown dolly, anvil dolly, angle & flat short double spoon, drip moulding spoon, light dinging spoon, short single spoon.

- Drop forged, heat-treated steel
- Precision ground and polished faces



**\$330**

H887

### Hydraulic 10t Panel Beating Kit

14pc kit includes: Hydraulic pump, 110, 265, 365 & 520mm extension tubes, 78mm round rubber head, round head, square head, tapered wedge head, cylinder toe, extension toe.

- Hydraulic fast/slow pump with hose and fittings
- 10-tonne ram (322-452mm range, 130mm stroke)
- Plastic carry case with wheels



**\$280**

A366

### Heavy Duty Parts Washer & Brush

Freestanding Auto Parts Washer & Brush Kit.

- 76 litre capacity
- 240V pump with 45 litre fluid capacity
- Flow rate approx. 180 L/hr
- Colours may vary



**\$231**

K6204T4I

### Bench Lathe Package

Includes lathe, lathe stand and tooling.

- Bench lathe with 320x600mm turning capacity and stand
- Lathe tooling: high-speed steel bits, carbide inserts, and parting tool holder



**\$4,125**

K6013T4I

### Industrial Work Bench Package

1800mm bench with 1000kg capacity. Includes an under-bench 2-drawer cabinet.

- Dimensions: 1800x750x900mm



**\$616**

K6014T4I

### Welding Table Package

1D welding table including 40-piece welding table clamp kit, locking clamps & corner magnets.

- Welding table precision cut from 5mm steel
- Supplied with clamps and corner magnets
- Note: This item comes flat packed and requires assembly and welding. Tools and welder required for assembly



**\$670**

K6023T4I



The LSZ Commins drive components are part of the broader range of centre pivot equipment used for efficient, large-scale agriculture.



**Standard Wheel Drive Gearbox**

- Filled with Premium Extreme Pressure GL5 Gear Oil
- Cartridge Input/Output Seals
- External Seal Protectors for input and Output Seals
- External Seal Protectors for Input and Output Seals
- Dual Ended Input Shaft with a Hub Cap for the Unused End
- Universal (13-Bolt) Mounting

From **\$636**



MI-7050 50:1 Short Axle **\$636**  
MI-7052 52:1 Long Axle **\$762**

**Universal Wheel Drive Gearbox**

- Vented, External Expansion Chamber with Rubber Diaphragm
- Filled with Premium Extreme Pressure GL5 Gear Oil
- Cartridge Input/Output Seals
- Dual Ended Input Shaft with a Hub Cap for the Unused End
- Universal (11/13-Bolt) Mounting

From **\$696**



MI-7150 50:1 Short Axle **\$696**  
MI-7152 52:1 Long Axle **\$710**

**Super Wheel Drive Gearbox**

- Vented, External Expansion Chamber with Rubber Diaphragm
- Filled with Premium Extreme Pressure GL5 Gear Oil
- Cartridge Input/Output Seals
- Dual Ended Input Shaft with a Hub Cap For the Unused End
- Universal (13-Bolt) Mounting

From **\$1,062**



MI-8050 50:1 Short Axle **\$1,062**  
MI-8052 52:1 Long Axle **\$1,038**

**Super Wheel Drive Gearbox – Towable**

- Vented, External Expansion Chamber with Rubber Diaphragm
- Filled with Premium Extreme Pressure GL5 Gear Oil
- Cartridge Input/Output Seals
- Dual Ended Input Shaft with a Hub Cap for the Unused End
- Universal (13-Bolt) Mounting

From **\$1,008**



MI-8150 50:1 Short Axle **\$1,008**  
MI-8152 52:1 Long Axle **\$1,020**

**Central Drive Geared Motor**

The Mi-LFNG series three-phase synchronous thermal protection motor inherits the advanced concepts of international efficient motor design and manufacturing.

From **\$828**



MI-LFNG75 0.75kW **\$828**  
MI-LFNG15 1.5kW **\$846**

**Coupling**

LZQ produces couplings and drive system parts used in large-scale agricultural irrigation. These couplings are critical for connecting the drive shafts between the motor, gearbox, and wheels to ensure the "spans" of the irrigator move uniformly.

**\$2340**



MI-LZQ

**TIMKEN**

# QUICK-FLEX® COUPLINGS

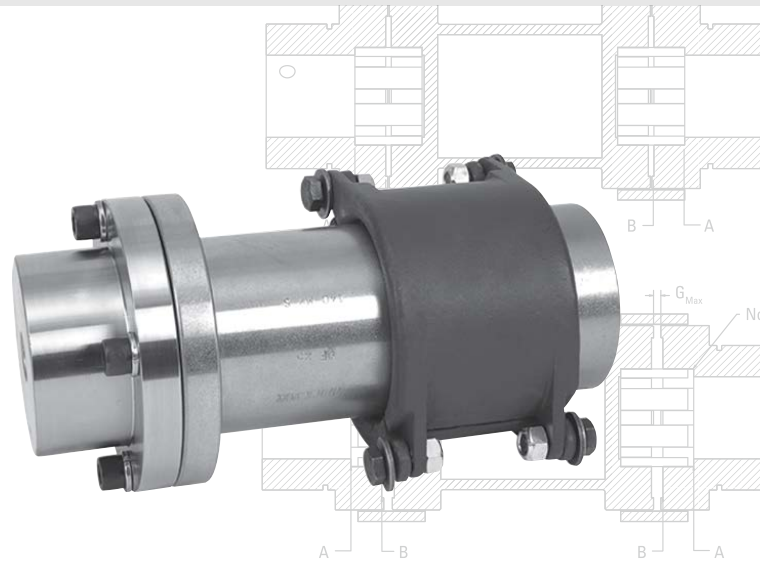

## Durability for the Long Haul

When your equipment operates in harsh environments, you need products you can count on, like Timken Quick-Flex elastomeric couplings. They are durable enough to face extreme challenges yet need minimal maintenance. They are also easy to install and require no lubrication. With a lifespan that may last as long as your equipment, overall cost of ownership remains low.

### Pioneering Design

Timken Quick-Flex couplings' innovative design features two steel hubs, a polyurethane insert and a cover.

Our styles include:

- Standard couplings.
- Single-ended spacer couplings.
- Double-ended spacer couplings.

Whatever your application, you'll find a Timken coupling to suit your needs:

- Twelve families with bore ranges from 10 mm (0.37 in.) to 285 mm (11.25 in.).
- Continuous torque handling from 0.043 kNm (377 in.-lbs.) to 188.8 kNm (1,670,826 in.-lbs.).
- Able to handle temperatures from -51° C to 176° C (-60° F to 350° F).

### Product Advantages

#### MORE UPTIME

Your hubs and shafts may remain intact when you use Timken Quick-Flex couplings. Our design helps eliminate mechanical interference between coupling hubs that can damage your equipment. As needed, you can replace the urethane insert quickly and easily without removing the hubs.

#### DURABILITY

There's no metal-to-metal contact between opposing hubs with Timken Quick-Flex couplings, so you'll save money not replacing hubs or other metal components since they do not wear. For harsh environments, including wash-downs for food processing, we offer a stainless-steel version of each coupling.

#### REDUCED INVENTORY

The versatility of the Timken Quick-Flex design promotes component standardization across your plant, reducing the need to stock multiple coupling styles and configurations.

### Product Features

- Solid and split covers handle high speeds and torque.
- Design dampens torsional vibration and shock.
- Accepts shaft misalignment up to 2 degrees.
- Eliminates the need to move or disassemble the driving or driven equipment to replace the coupling insert.
- Versatility of design makes it a great tool for plant standardization.
- Accepts shaft sizes from 10 mm (0.37 in.) to 285 mm (11.25 in.).
- Peak handling torque from 0.085 kNm (754 in.-lbs.) to 377.5 kNm (3,341,562 in.-lbs.).
- Standard and double-ended spacer couplings available for shaft separations of 25.4 mm to 3,048 mm (1 in. to 120 in.), for increased application acceptance.
- Four bore options available to meet customers' needs...
  1. Bored, keyed, and set screws style – clearance and interference fit
  2. Bushing style
  3. Splined style
  4. Mill-motor style.
- Stainless-steel versions available for corrosive environments.
- Four insert choices for varying torque needs and temperature ranges, up to 177° C (350° F).
- Replaces many common gear, grid and elastomeric couplings used in high- and low-torque applications to reduce plant complexity.
- Inherently balanced from precision machining for highspeed applications.
- Split-cover options help resist axial separating force under high torque.

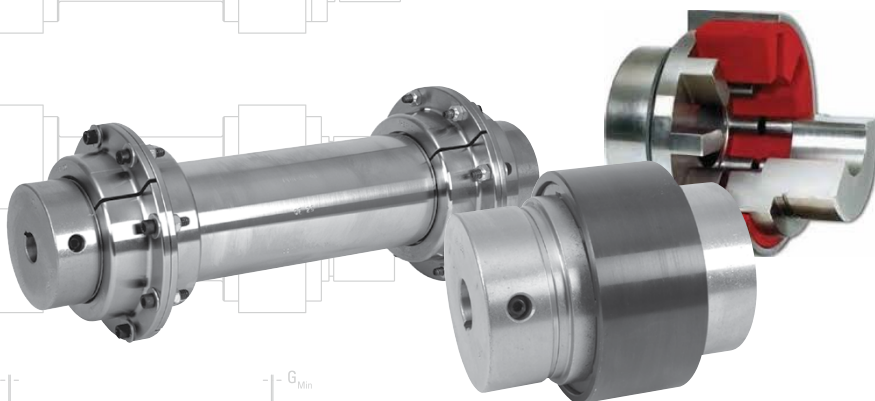
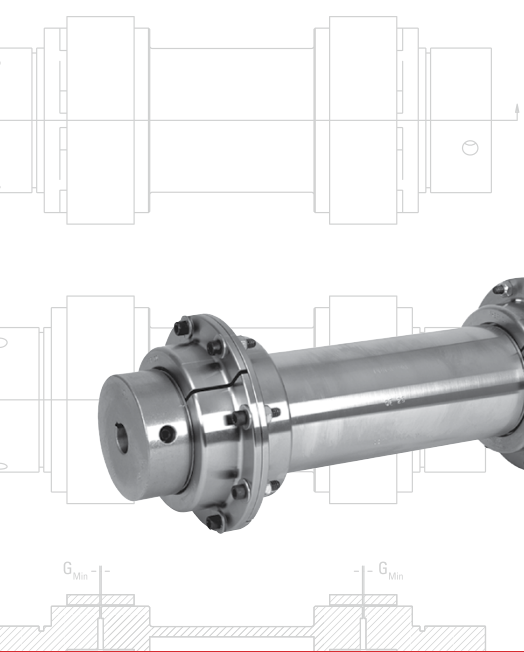

## **TITAN** LIFTING TECHNOLOGIES

### **NXTGEN Chain Block**

NXTGEN Overload Protection built in safety feature.

- Suitable for all applications- high & light end industries
- Proof Tested WLL x 1.5
- Reliable and durable to withstand high usage, servicable parts available

From **\$369**



K0503TTN	500kg	3m	<b>\$369</b>
K0506TTN	500kg	6m	<b>\$425</b>
K1003TTN	1tn	3m	<b>\$425</b>
K2003TTN	2tn	3m	<b>\$489</b>
K3003TTN	3tn	3m	<b>\$639</b>

### **NXTGEN Lever Hoist**

NXTGEN Overload Protection built in safety feature.

- Suitable for all applications- high & light end industries
- Proof tested WLL x 1.5
- Reliable and durable to withstand high usage
- Serviceable parts available

From **\$425**



KV00815TTN	800kg	5m	<b>\$425</b>
KV01615TTN	1.6tn	5m	<b>\$549</b>

### **Winch Lever and Handle C/W 20mtr Rope**

Suitable for lifting, pulling, and positioning loads over long distances, Pulling Capacity 1600kg, Complies EN13157 standard.

- Off road recovery
- Suitable for Vehicle recovery & farm usage, Complies with AS1418

From **\$679**



WIUT1620TTN	1.6tn	20m	<b>\$679</b>
WIUT3220TTN	3.2tn	20m	<b>\$1,099</b>

### **Off Road Block 125mm**

Pulling Capacity 8T, Wire Rope dia. 11mm, Fitted with grease nipple.



**\$55**

ORB125TTN

### **Truck Winch**

Truck Winches used in conjunction with Webbing to secure loads on trucks.

- Lashing Capacity 2500kg
- Uses 50mm Transport webbing
- Ratchet tightening feature
- Complies with AS4344

**REPLACEMENT STRAPS AVAILABLE**

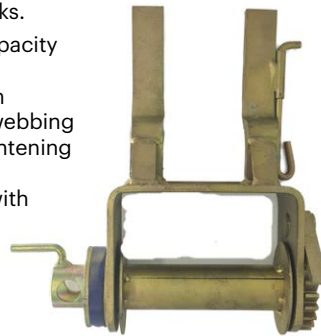

From **\$105**

TTWC3000TTN	Clip On Type - No Strap	<b>\$105</b>
TTWC3009TTN	Clip On Type - Inc. 9m Strap	<b>\$125</b>
TTWS3000TTN	Slide On Type - No Strap Slide	<b>\$85</b>
TTWS3009TTN	Slide On Type - Inc. 9m Strap	<b>\$119</b>
TTW3000BTNN	Tensioning Bar 540MM	<b>\$22</b>

### **Ratchet Loadbinder**

Ratchet type load binder for load restraint.

- Available in red or yellow
- With windout/runout safety stop pin
- Batch marked for traceability
- Fitted with cradle (wing) grab hooks
- Complies with AS/NZS 4344 Transport standard



From **\$39**

HTLBRCG6RTTN	6mm	Red	2.3tn	<b>\$39</b>
HTLBRCG6YTTN	6mm	Yellow	2.3tn	<b>\$39</b>
HTLBRCG8YTTN	8mm	Yellow	3tn	<b>\$54</b>
HTLBRCG8RTTN	8mm	Red	3tn	<b>\$54</b>
HTLBRCG10RTTN	10mm	Red	6tn	<b>\$62</b>
HTLBRCG10YTTN	10mm	Yellow	6tn	<b>\$62</b>
HTLBRCG13YTTN	13mm	Yellow	9tn	<b>\$84</b>
HTLBRCG13RTTN	13mm	Red	9tn	<b>\$84</b>

### **Green Pin Big Mouth Shackle**

Perfect for use with wide connecting points due to wide shackle mouth, heavy-duty rigging and lifting connector.

- Wider shackle mouth
- Hot-dipped galvanised finish
- Suitable for multiple rigging configurations

**\$179**



SSSBMGP-4.75T	4.75tn	<b>\$179</b>
SSSBMGP-6.5TTTN	6.5tn	<b>\$195</b>
SSSBMGP-8.5TTTN	8.5tn	<b>\$319</b>
SSSBMGP-9.5TTTN	9.5tn	<b>\$435</b>
SSSBMGP-12T	12tn	<b>\$549</b>

### **Vehicle/Tyre Restraint Ratchet Tie Down**

Suitable for securing vehicles down on vehicle transport trucks.

- LC 2500kg
- Complies with AS4380

**\$29**



WRSSJ5035-25VR

### **Builder Hoists**

Wireless Electric Builders Hoist WLL 250kg.

- Wireless Model: JUUKO wireless remote control (50m range), electromagnetic & mechanical brake TBH-230-WRCTTN - Pictured
- Pendant Model: Hand-held control pendant with safety switch, double safety brake, automatic stop switch (anti-overwind), compact design (mounting bracket optional)



**\$2,495**

TBH-230-10TTN	Electric	<b>\$1,495</b>
TBH-230-WRCTTN	Wireless	<b>\$2,495</b>

## MOLYKOTE®

### Molykote G-4500 FM Multipurpose Synthetic Grease 25kg

- Wide service temperature range
- Compatible with many plastics & elastomers
- NSF H1 certification
- NLGI 2
- White in colour
- High load carrying capacity

**\$1,809**



**FOOD GRADE LUBRICANTS  
SUPER SPECIALS**

**FOOD GRADE LUBRICANTS  
SUPER SPECIALS**

### Molykote G-0052 FM White EP Bearing Grease 15kg

- Good resistance to water washout
- High load carrying capability
- NSF H1 certification
- NLGI 2
- Multipurpose – various applications

**\$948**



4029577

4073868

**FOOD GRADE LUBRICANTS  
SUPER SPECIALS**

### Molykote P-1900 FM Anti-Seize Paste 1kg

- Fastener & component assembly
- NSF H1 certification
- NLGI 1
- Low & high temperature performance
- High load carrying capability

**\$86**

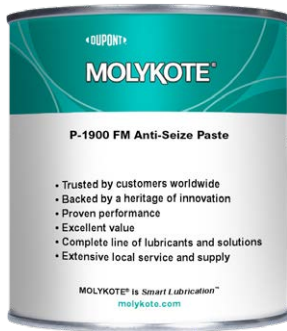

**FOOD GRADE LUBRICANTS  
SUPER SPECIALS**

### Molykote G-4501 FM Multipurpose Food Grade Grease 25kg

- Wide service temperature range
- Compatible with many plastics & elastomers
- NSF H1 certification
- NLGI 1
- White in colour
- High load carrying capacity

**\$998**



**FOOD GRADE LUBRICANTS  
SUPER SPECIALS**

### Molykote G-0050 FM White EP Bearing Grease 380g

- Good resistance to water washout
- High load carrying capability
- NSF H1 certification
- NLGI 0
- Soft & pumpable

**\$49**

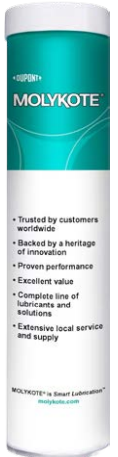

4118058

25KGG4501MKT

4052320

### Molykote 41 Extreme High Temperature Grease 100gm

- Extreme temperature performance
- Silicone base oil
- Non-melt formulation
- NLGI 2

**WHILE  
STOCKS LAST**

**\$32**



1212945

### Molykote 44M High Temperature Grease 25kg

- Low evaporation rate
- Silicone base oil
- High temperature performance
- Water resistant

**WHILE  
STOCKS LAST**

**\$2,639**



4016048



**Emergency Baler Release System - For Square balers**

The emergency release system is designed to minimise the risk of fire spreading from your baler to your tractor.

Suits the common big square balers models.

- Safe operation in case of a fire spreading from a baler
- Disconnection of baler from the safety of your tractor
- Re-usable after each disconnection
- 80mm ball coupling as standard (optional ring eye available if required)
- Available to suit: Case, Claas, Fendt, Krone, Massey Ferguson and New Holland balers

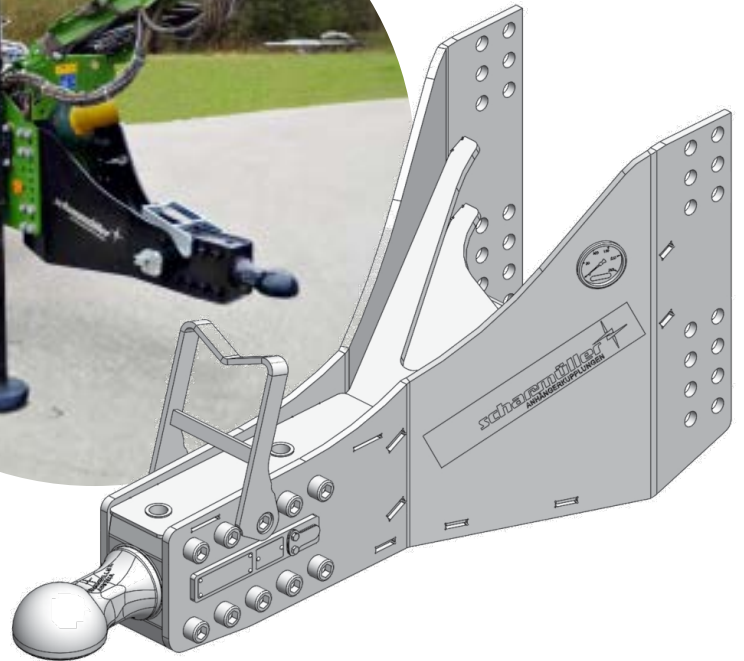

40.744.06.0-SET

**Multi-Fit Front Linkage**

The Multi-Fit Front Linkage is designed for retrofitting to a wide range of tractor models.

This unit offers a 3-ton lifting capacity and is also available in a smaller model with a 1.8-ton lifting capacity.

Also available in PTO-driven versions to suit many models, including Kubota, New Holland, Deutz-Fahr, John Deere, Fendt, and more.



FL10.000.254001

# SW45 THE PROFESSIONAL SPECIALIST TOOL



## RAPID, RELIABLE ASSEMBLY & DISASSEMBLY

The new SW45 tool from the Walterscheid Service Department was developed for the assembly and dismantling of joints.

- ▶ Only minimal effort is required for dismantling and assembly, so that the work can be carried out fatigue-proof. With wide-angle joints, there is even no need for the frequently called in second person.
- ▶ Bearing caps are now mainly handled in a clean environment. Individual components can no longer be lost, as is otherwise common when using a normal vice and hammer.
- ▶ For a broad compatibility of cross-brand cardan shafts, the repair of universal joints and cardan joints has never been easier, safer, more environmentally friendly and more cost-effective.
- ▶ Joints can also be assembled on shaft halves without difficulty.
- ▶ Once the bearing caps are removed from the joint, they can be re-used again.
- ▶ Considerable amounts of time can be saved when dismantling joints of all kinds - particularly when working with wide-angle joints

Series	Replacement profiles/joints		No. of workers per assembly	Assembly costs		Savings per operation	Quantity per year	Savings per year
	without SW45	with SW45		without SW45	with SW45			
	(min)	(min)						
W2100 - W2300*	20	10	1	\$40	\$20	\$20	12	\$240
W2400 - W2700*	25	12	1,5	\$75	\$25	\$55	15	\$760
P400 - P700*	25	12	1,5	\$75	\$25	\$55	15	\$760
WW2280 - WW2580*	35	15	2	\$140	\$30	\$110	15	\$1610
PW480 O PW675*	35	15	2	\$140	\$30	\$110	15	\$1610
Total, all repairs							72	\$5000

\*Note: This analysis is based on average values, assuming an internal hourly rate of \$120. The tool's payback period can vary, depending on the situation of the tool.



Cardan shafts can be rotated 360° around the centre axis and be moved along the longitudinal axis at will. As a result, the SW45 offers **excellent accessibility to cross and bearing bushes.**



**High level of work safety** thanks to the elimination of a striking tool.



The SW45 is able to cope with even the **heaviest cardan shafts.**

## ADDITIONAL BENEFITS

- ▶ Less damage to individual components during assembly
- ▶ Less stress in difficult working conditions
- ▶ Less consequential damage
- ▶ Considerably better assembly quality
- ▶ Significant time savings, reducing the pressure of deadlines
- ▶ Tools can pay back within one year



**Find your local branch**

Motion.com.au

# WALTERSCHEID

## Walterscheid Cotton Picker Shaft

Suits John Deere pro 16 picking heads - 40inch row centres. Available in 60inch and 80inch available upon request.



W2200-SP-49

## Goldacres Crop Cruiser

Suits Goldacres Crop cruiser- fits diff to drop leg.

- Fits diff to drop leg
- Complete driveline with end yokes and universals
- Genuine Walterscheid 2600 series components
- German-built quality to keep your customers cruising
- Ready to ship nationally from our state warehouses

**5 OR MORE  
QUANTITY  
SPECIAL POA**



WF2600-S6-544

## Walterscheid Chaser Bin/ Trailing Implement Shaft

Wide angle shaft P series, fitted with 1-3/8 x 6 spline on tractor end and 1-3/8 x 6 clamp lock on implement end.

Available in many other combinations.



PWE580-SS-1211

Unlock Better Solutions with

# KNOWLEDGE HUB

Technical insights, practical solutions and trusted literature — all in one place.

SCAN ME



EXPLORE THE FULL KNOWLEDGE HUB ONLINE!

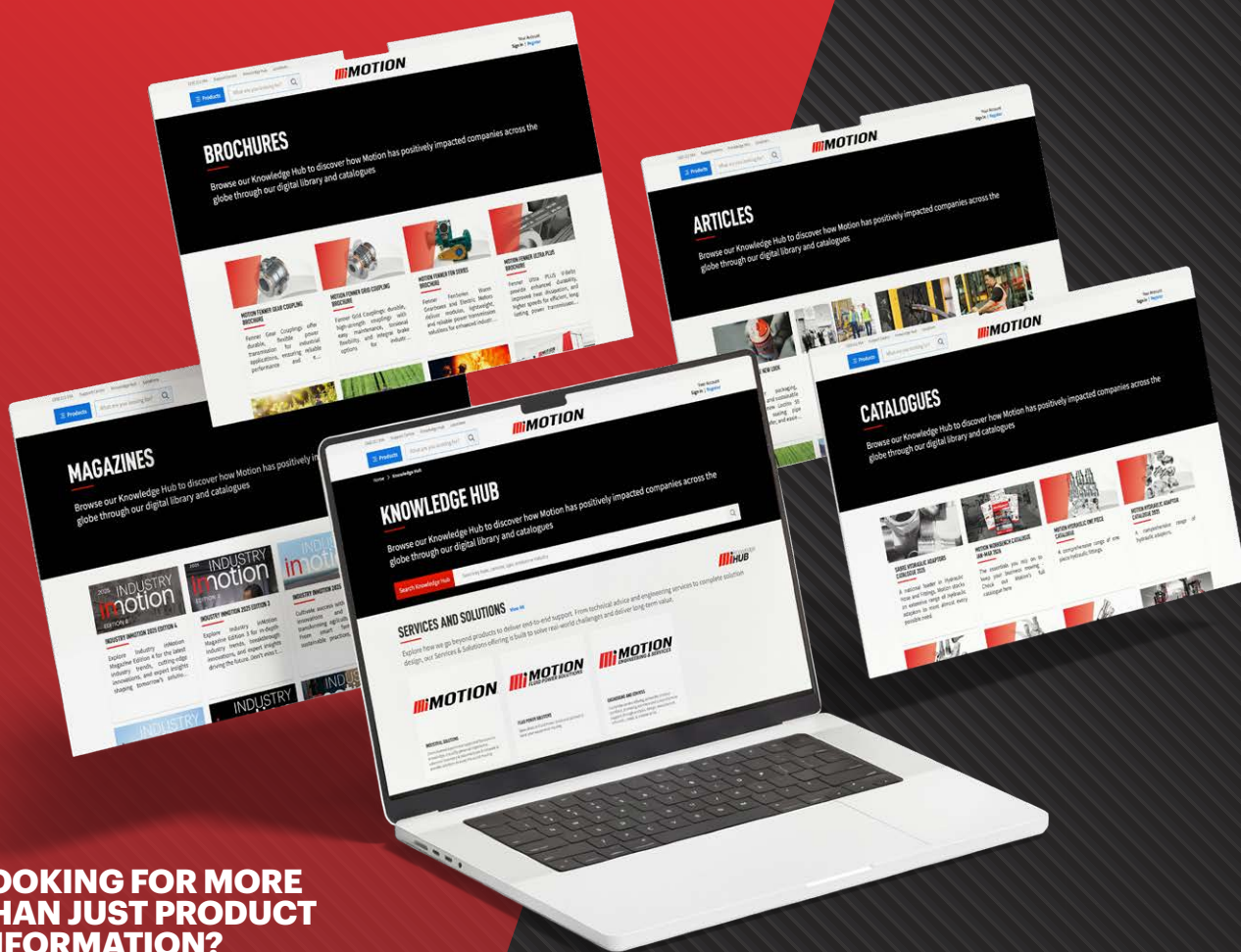

## LOOKING FOR MORE THAN JUST PRODUCT INFORMATION?

Motion's Knowledge Hub brings together expert articles, real world case studies and comprehensive technical literature to help you make informed decisions on site and in the workshop.

- ➔ Practical expertise
- ➔ Real world solutions
- ➔ Industry backed insights
- ➔ Easily accessible digital resources



**Shell Lubricants Reseller**

## Shell Tellus S2 MX 46 – 20L

High performance hydraulic fluids based on Group II base oils that provide outstanding protection and performance in most manufacturing and many mobile equipment operations.

- Long Fluid Life – maintenance saving
- Outstanding wear protection
- Maintaining system efficiency
- Resists breakdown under heat or mechanical stress



310277803

## Shell Omala S2 GX 220 – 20L

High quality extreme-pressure (EP) oils designed primarily for the lubrication of heavy duty industrial gearboxes. Their high load carrying capacity, protection against micropitting and compatibility with seals and paints, combine to offer excellent performance in enclosed gear applications.

- Long oil life through oxidation stability and resistance to thermal stress - leading to reduced total cost of ownership
- Excellent wear and micropitting protection
- Gear system efficiency is maintained by optimised water separation performance, corrosion and foam control



300012355

## Shell Omala S2 GX 320 – 20L

High quality extreme-pressure (EP) oils designed primarily for the lubrication of heavy duty industrial gearboxes. Their high load carrying capacity, protection against micropitting and compatibility with seals and paints, combine to offer excellent performance in enclosed gear applications.

- Long oil life through oxidation stability and resistance to thermal stress - leading to reduced total cost of ownership
- Excellent wear and micropitting protection
- Gear system efficiency is maintained by optimised water separation performance, corrosion and foam control



300012361

## Shell Tellus S2 MX 68 – 209L

Shell Tellus S2 MX fluids are high performance hydraulic fluids based on Group II base oils that provide outstanding protection and performance in most manufacturing and many mobile equipment operations.

- Long Fluid Life – maintenance saving
- Outstanding wear protection
- Maintaining system efficiency
- Resists breakdown under heat or mechanical stress



300012744

## Shell Ondina 15 – 20L

Highly refined, non-additive, aromatic-free paraffinic white mineral oils complying with the stringent pharmacopoeia purity requirements. Can be used in pharmaceutical, food packaging, cosmetic and other applications, where this high purity is required by legislation or important for the quality of the finished product.

- Optimal quality control
- Excellent stability



300003554

## Shell Ondina 68 – 20L

Highly refined, non-additive, aromatic-free paraffinic white mineral oils complying with the stringent pharmacopoeia purity requirements. Ondina oils can be used in pharmaceutical, food packaging, cosmetic and other applications, where this high purity is required by legislation or important for the quality of the finished product.

- Optimal quality control
- Excellent stability



300003584

## Shell Heat Transfer Oil S2 – 209L

Based on carefully selected, highly refined mineral oils chosen for their ability to provide superior performance in indirect closed fluid heat transfer systems.

- High performance heat transfer fluid
- Extended maintenance intervals
- System efficiency
- Wear protection



300011321

## Shell Corena S2 P 100 – 20L

A high quality air compressor oil designed to deliver the lubrication performance for high pressure reciprocating compressors.

- Reciprocating (piston) air compressor oil
- Long oil life
- Maintenance saving
- Outstanding wear protection
- Maintaining system efficiency
- Enhanced air line safety



300011297

## Shell Rimula R4 L – 20L

Uses "Low-SAPS" additive technology to protect low emission engines under severe conditions. It delivers improvements in wear and deposit control, resistance to breakdown under high temperatures compared to previous oil.

- Heavy duty diesel engine oil
- Simplify inventory needs
- Emissions system capability
- Lower operating costs
- Outstanding wear protection



300012872

## SUPER SPECIALS

### Tough-As Motion Australia Work Mat

2.0 x 1.0m work mat.

- Chemical, stain, tear and cut resistant
- Durable, premium grade PVC outer
- Closed cell, soft high density foam inner
- Waterproof
- 5year UV warranty

**NEW COLOUR AVAILABLE!**



**\$198** EA

WM-L-REDMOTION Red  
WM-L-YELMOTION Yellow

### 3M Silver Cut-Off Wheels 125mm Bucket – 100 Pack

A premium performance wheel designed to be affordable for everyday use.

- 125mm x 1mm x 22.23mm
- Featuring 3M Precision Shaped Ceramic Grain technology
- Deliver fast, smooth cutting action through pipes, tubes or flat sheets of all types of ferrous metals, stainless steels and alloys
- Bonus Solus 1000 Series Safety Eyewear included



**\$199**

AC019441313

### Cigweld Arcmaster Blax Welding Helmet

- Viewing Area: 96mm x 40mm
- Arc Sensors: 2
- Shade Range: 4-8/9-13 + Grind
- Switching Speed: 0.2ms

**NEW**



**\$68**

WHAMXC010CIG

### 3M Cubitron 3 1182C Fibre Disc Bucket

50x 125mm 1182C fibre disks 36 grit.

- Bonus: 1x 3M high performance back-up pad
- 5x 125mm Cubitron 3 cutting disks

**BULK BUY AND SAVE! WHILE STOCKS LAST!**



**\$195**

7012888353

### Alemlube EL Series Hot Water Hose Reel 15m x 10mm ID with Gun

EL Series hot water hose reel with heavy duty wash down gun.

- Supplied with a heavy duty pull trigger hose down nozzle-constant speed control-working pressure to 300psi-working temp up to 80c



**\$386**

HR30070CALM

### FLIR Moisture Meter with MSX IR Camera & Hygrometer

Building Inspection System with Moisture Hygrometer & MSX® IR Camera.



**\$1,995**

MR277FLI

METER LINK Bluetooth

### 3M™ Temflex™ 160 Vinyl Electrical Tape

A multi-purpose, general use grade, electrical insulating tape composed of PVC film backing coated on one side with a noncorrosive, pressure-sensitive adhesive.

- Temperature range: 0°C - 80°C
- Thickness: 0.15mm
- Marking of safety areas and equipment and phase coding.
- Primary insulation on applications up to 600V

7100374494	Black	\$1.20
7100374339	Red	\$1.20
7100374454	Blue	\$1.20
7100374484	White	\$1.20
7100374565	Yellow-Green	\$1.20
7100374341	Rainbow Pack	\$12



**From \$120**

**WHILE STOCKS LAST**

**I18R Led Lenser Flashlight  
3000 Lumen 540M  
Rechargeable**



**\$289**

ZL500928LLE

**Hi-Tensile Grade 70  
Transport Chain – Gold  
Zinc Plated**

Strictly supplied as 50kg drum,  
priced per metre.

- Complies with AS/NZS 4344

From  
**\$250**



HITEN6MM/M 62m 2,300kg **\$350** Per drum @ **\$5.64** per metre  
 HITEN10MM/M 22m 6,000kg **\$275** per drum @ **\$12.47** per metre  
 HITEN13MM/M 13m 9,000kg **\$250** per drum @ **\$19.23** per metre

**i9 LED Lenser Flashlight  
400 Lumen 260m**



**\$90**

ZL5609LLE

**XEO19R Led Lenser Headlamp  
2x1000 Lumen, 300M  
Rechargeable**

**\$299**



ZL7219RGLLE

**Hot Devil Super  
Cyclone Trade  
Map Kit**

- Auto ignition
- Swirl flame action
- Fast heat transfer
- CGA600 thread



**\$45**

HD8096-HD

**Alemite 20V Lithium-Ion  
Cordless Grease Gun**

The 670AN5 20V Lithium-ion cordless grease gun from Alemlube is an innovative grease gun with built in intelligence and a new and powerful 4.0Ah battery.

- Grease pressures of up to 10,000psi (690bar)
- Up to 35 cartridges per battery charge
- Built in Intelligence
- LCD with real time battery capacity, grease level and grease metering information



**\$1,334**

670AN5ALM

**sutton**

**10pc Ezy-Out Set  
with L/H Cobalt  
Drills**

No. 1-5 Screw Extractors with LH Cobalt Drills made to the highest standard for the toughest job.

- No. 1-5 Screw Extractors
- LH Cobalt Drills

**AUSTRALIAN  
MADE**

**\$126**

M603S20LSUT



**HP15-200E GT Spitwater Pressure Washer**

Cold water, direct drive, 15 LPM, 2900 PSI, wall/base mounted, 7.5 HP electric, 20A, 415V.

- Reliable Interpump: Ensures longer pump life with reduced maintenance
- Water Cooling Tank: Protects pump seals from overheating in bypass mode
- In-line Filter: Shields pistons and seals from damage
- Stainless Steel Frame & Cover: Provides superior corrosion resistance
- Australian Made: High-quality product designed for industrial performance

**\$7,600**



HP15-200ESPI

**sutton**

**25pc TiAlN 1/4"  
Shank Supabit  
Plus Drill Set**

TiAlN Coated 1/4" Hex Shank Impact Rated Drill Set with Parabolic Flute Design.

- TiAlN Coated - Impact Rated
- 1/4" Hex Shank
- 2-13mm

**\$149**



D221S25ASUT



**iMOTION**

Delivering a world-class customer-first approach providing excellence and expertise in industrial products, solutions and services.

**iMOTION**  
FLUID POWER SOLUTIONS

Specialists in Fluid Power Solutions tailored to keep your equipment moving.

**iMOTION**  
ENGINEERING & SERVICES

Specialist design and engineering, manufacturing, repair and maintenance services.

Anytime. Anywhere.  
**Always Here.™**



**Find a location near you!**

Scan the QR Code to find out more or visit [Motion.com.au](https://www.motion.com.au)